



SEIKO WATCH CORPORATION
www.grand-seiko.com

BSJ9SCCG-2002
Printed in Japan



GS
Grand Seiko

Mechanical
Operating Instructions

Thank you very much for choosing a Grand Seiko watch.
 For proper and safe use of your Grand Seiko watch, please
 read the instructions carefully in this booklet before using it.

Keep this manual handy for easy reference.

Bracelet sizing is available at the retailer from whom the watch was purchased. If you cannot have your watch band sized by the retailer from whom the watch was purchased because you received the watch as a gift, or you moved to a distant place, please contact Grand Seiko international service network mentioned on CERTIFICATE OF GUARANTEE or our website. The service may also be available on a chargeable basis at other retailers, however, some retailers may not undertake the service.

If your watch has a protective film for preventing scratches, make sure to peel it off before using the watch. If the watch is used with the film on it, dirt, sweat, dust, or moisture may be attached to the film and may cause rust.

CONTENTS

■ INTRODUCTION -About mechanical watch-	2
• Characteristics of a mechanical watch	3
• For lifelong use of your mechanical watch	5
■ CAUTIONS FOR ACCURACY	8
■ HANDLING CAUTIONS	9
■ CHECK THE CALIBER NUMBER AND WATER-RESISTANT LEVEL	10
■ CAUTIONS ON WATER RESISTANCE	11
■ NAMES OF THE PARTS	15
■ HOW TO USE	18
• Crown	18
• Power reserve indicator	19
• HOW TO USE (FOR CAL. 9S85, 9S68, 9S65, 9S27)	20
• HOW TO USE (FOR CAL. 9S86, 9S66)	22
※ List of time zone differences in major regions of the world	29
• HOW TO USE (FOR CAL. 9S64, 9S63)	30
• HOW TO USE (FOR CAL. 9S61)	32
■ FUNCTIONS OF DIVER'S MODEL	33
• Unidirectional rotating bezel	33
• Slide adjuster	34
■ THE GRAND SEIKO STANDARD	35
• The Grand Seiko Standard Inspection Certificate	37
• Cautions for accuracy of mechanical watch	38
■ TO PRESERVE THE QUALITY OF YOUR WATCH	39
• After-sale service	39
• Guarantee	40
• Daily care	41
• Band	42
• Magnetic resistance (Magnetic influence)	43
• Lumibrite	44
• Troubleshooting	45
■ SPECIFICATIONS (Movement)	46

INTRODUCTION -About mechanical watch-

Thank you very much for purchasing the Grand Seiko mechanical watch.

Take hold of your watch softly.

Hear the watch ticking,

tick tock, tick tock, tick tock,

soft and faint, a dignified sound can be heard.

The sound can be called

the crystal of the craftsmen's spirit and skill.

Handpicked parts assembled one by one,

carefully, with craftsmanship,

giving life to a mechanical watch.

This is proven by the sound.

Talking about accuracy,

mechanical watches cannot be compared to

quartz watches, that is for certain.

However, the accuracy of a mechanical watch

is pursued by human hands.

Full of spirit and know-how of craftsmen.

A mechanical watch - complicated, sensitive,
and having a human touch.

We would like to let all of you know

the charm of a mechanical watch, which has no bounds.

So we made this handbook, mainly detailing the accuracy.

Wishing you will have a nice time

with your Grand Seiko for a long, long time.

SEIKO WATCH CORPORATION

Quartz watches and mechanical watches - what is the difference?

We will explain by example

Quartz watches that you have come to be familiar with.

These are just like airplanes, controlled by computers.

A battery, IC, and crystal make quartz watches work accurately, electrically.

Some loss or gain may occur while the watch is worn.

However, this will be too small to notice in your daily life.

If a quartz watch resembles an airplane, a mechanical watch is like a bicycle.

All watch parts work together mechanically to make it tick.

Thus, a mechanical watch is easily affected by the outside environment.

If it is hot, the watch tends to lose time. When power driving the watch becomes short (when the amount the spring is wound is short), accuracy becomes unstable.

If the resting position of the watch is changed, accuracy is also affected.

The rate of loss/gain could be significant that you will notice in your daily life.

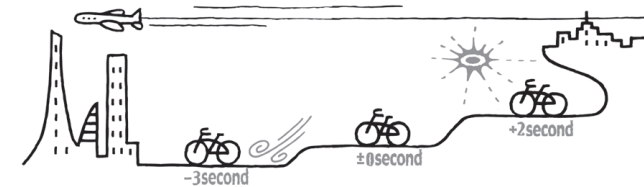

The accuracy is shown by the daily rate



The measured loss/gain of the watch per day
This is called the daily rate.

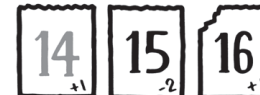

The accuracy of a mechanical watch is usually shown in this daily rate.

The accuracy of a mechanical watch changes delicately day by day, depending on the condition in which the watch is used or the outside environment.



Thus,

By only observing loss/gain in one day, you cannot judge how accurate the watch works.

If you check the average of the daily loss/gain rate, you can judge the accuracy of the watch.

7

In the case of quartz watches, the accuracy is usually shown by the monthly/yearly rate.

Total losses/gains for a month/year are called the loss/gain rate of quartz watches.

Mean daily rate / Normal usage accuracy

The accuracy of a mechanical watch varies depending on many things, such as the amount the spring is wound by movements of your arm, temperature, or resting position of the watch.

Thus to show the accuracy of a mechanical watch evenly, not depending on the environment, loss/gain of a mechanical watch is measured before the inside movements of the watch are put in the case, under controlled conditions, with many days of tests. And the measured rate is called "mean daily rate".

In both the ISO3159 and Grand Seiko Standard*, the standard rate is mean daily rate.
* "THE GRAND SEIKO STANDARD" P. 35

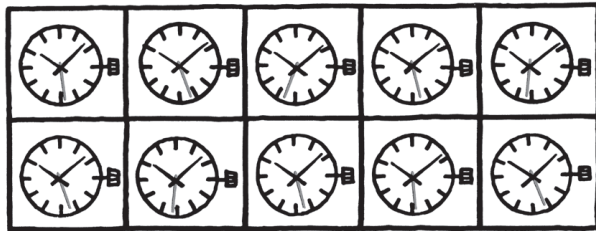

This rate is the data measured in an environment that is artificially controlled, in order to fairly evaluate/show the abilities of mechanical watches without being influenced by environmental changes. So it is different from "normal usage accuracy" when you are actually wearing the watch.



The accuracy of a mechanical watch varies delicately day by day, depending on the environment. This is like a living thing, one of the charms that a mechanical watch has.

Normal usage accuracy should be from -1 second/day to +10 seconds (-1 to +8 seconds for Cal. 9S86 and 9S85, -5 to +10 seconds for Cal. 9S27) /day. If the average of the daily rates exceeds this level, we would like the responsibility for adjusting it accordingly (The cost of adjusting the watch is free of charge for three years from the date of purchase.)

To adjust the accuracy as accurately as possible, information such as the rate of loss/gain of your watch and how you use it, are very important. Please let us know the following when you ask for adjustment of your watch by our service center.

- (1) The average daily loss/gain rates for one week to ten days
Ex. an average of +11 seconds
- (2) Approximate hours of wearing the watch in one day in the above period
Ex. Approximately 10 hours
- (3) The resting position of the watch while you don't wear it
Ex. Horizontal - Dial up
Vertical - the crown up

For lifelong use of your mechanical watch rule No.1

Wind the mainspring of your mechanical watch at a fixed time.

As there are rules for everything, there is a rule for winding the spring.

You have not heard this before?
Please keep it in mind.

The mainspring - the source of energy for a mechanical watch. When it is fully wound, it can supply the most stable energy to every part of the watch movement, and the accuracy of the watch becomes most stable.

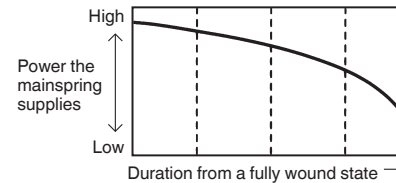

If your watch is a wind-up mechanical type, turn the crown every day, at a fixed time to wind the mainspring sufficiently.

To use the watch with better accuracy, wind the mainspring every day, at a fixed time. Please keep to this rule as best as possible.

For instance, You may make it a rule to wind the spring When you wake up, or at lunchtime.



Even if your watch is a self-winding type, when you feel the accuracy is not stable, turn the crown to wind the mainspring further. If you work at a desk, etc., and do not move too much, the spring will not be wound sufficiently.

For lifelong use of your mechanical watch rule No.2

Place your watch correctly, like this.

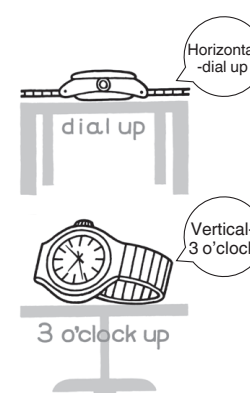

Half of one day, twenty-four hours, when you do not wear your watch. The accuracy while you do not wear the watch is included in "normal usage accuracy".

The mechanical watch that you take off. Which position should the watch be put in?

The loss/gain of a mechanical watch depends on the resting position of the watch. In one position, the watch tends to gain, in another position, it doesn't.

For instance, while you are sleeping at night, when you do not wear your watch, put the watch in various positions for seven to eight hours, such as placing it with its face turned up, or with the crown up, to find the best resting position for the watch for reducing the loss/gain that occurs while you are wearing your watch.

For lifelong use of your mechanical watch rule No.3

Accuracy will vary depending on the temperature.

A piece of metal of about 0.1 mm, as thin as a hair, is wound.

That is the key that controls the accuracy of all mechanical watches.

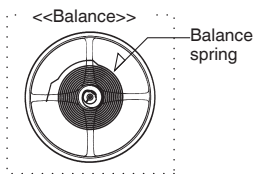

Metals expand and contract depending on the temperature.

This characteristic of all metals also applies to the balance spring.

This affects the accuracy of a mechanical watch.

In other words,

When it is hot, the balance spring expands and the watch tends to lose.

When it is cold, the balance spring contracts and the watch tends to gain. This is typical.

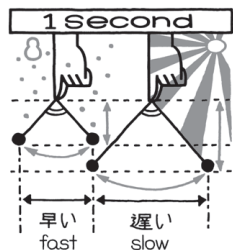

For lifelong use of your mechanical watch rule No.4

Keep your mechanical watch away from magnetic objects.

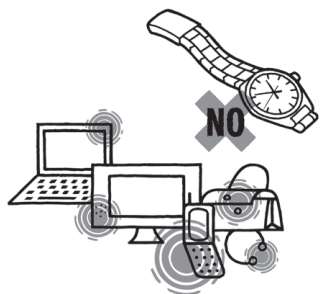

After you take off your watch, do you leave it by your cell phone? Or put it on a television or next to your PC? Do you put it in your bag with your cell phone?

Watches do not like magnetism. They may lose or gain when affected by magnetism.

To make your mechanical watch work more accurately, it is important not to leave the watch close to magnetic objects for a long time.

In particular, cell phones, televisions and speakers of PCs have strong magnetism.

A magnetic necklace, a clasp of a handbag, magnetic parts of refrigerators, there are many magnetic objects around us. Please be careful.

For lifelong use of your mechanical watch rule No.5

Do not give your mechanical watch a strong shock.

When you play golf, tennis or baseball.

When you play a sport that gives your arm a strong impact.

Please take off your mechanical watch.

There are reasons for this.

For instance, at the moment you hit a golf ball with a club, the impact of the ball against the club is about 1 ton.

The impact is given to your wrist, and this will affect very small parts inside your mechanical watch.

Sometimes, the impact will deform or break a watch part. "Good shot" for you becomes "bad shock" for your watch.

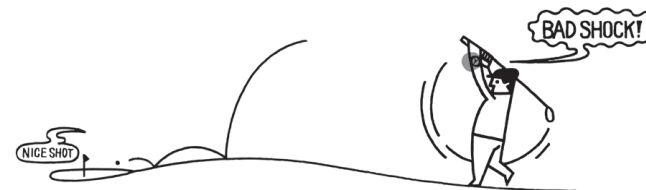

For lifelong use of your mechanical watch rule No.6

Overhaul, once every three years

Love your watch, once every three years. Talk about an overhaul.

In the case of a mechanical watch, there is no need to change your battery. However, maintenance of your watch is also necessary.

Once every three years, please take your watch to our service center for examining and cleaning every part of your watch.

Once you start using it, your watch never takes a rest.

And in the case of a mechanical watch, power given to its gear is stronger, compared to a quartz watch. So parts may wear, oil may dry or be insufficient in some parts.

Especially, the first three years after you start using your watch is the period when each part gets used to one another, and contacting each other causes additional metal powder.

The first overhaul is the key to the life of your mechanical watch.

Please keep in mind an overhaul, once every three years

can be considered love for your watch.



■ CAUTIONS FOR ACCURACY

- Normal usage accuracy of a mechanical watch varies depending on individual customer's use conditions such as winding state of the mainspring by movement amount of the customer's arm per day, temperature environment, and position (orientation of a watch). Accordingly, the actual normal usage accuracy when the watch is used by a customer may differ from the numerical value of each item specified in the Grand Seiko Standard.
- The target range of normal usage accuracy when the watch is actually used by a customer is set to -1 to +10 seconds (-1 to +8 seconds for Cal. 9S86 and 9S85, -5 to +10 seconds for Cal. 9S27) per day.
To correctly judge the normal usage accuracy, please use the watch for not only one day, but also approximately one week to 10 days under normal use conditions to check loss or gain of time. If the average value per day exceeds the target range, we will adjust the watch. (Adjustment is provided free of charge for three years after purchase, then charged thereafter. For more details, please refer to the instruction manual.)
- The enclosed Grand Seiko Standard Inspection Certificate certifies the values of a movement single unit before assembly in a case which are measured under an artificially controlled environment in the production factory passed the Grand Seiko Standard Inspection. Should the certificate be lost or after repair or adjustment, it cannot be reissued.

■ HANDLING CAUTIONS

⚠ WARNING To indicate the risks of serious consequences such as severe injuries unless the following safety regulations are strictly observed.

Immediately stop wearing the watch in the following cases.

- If the watch body or band becomes edged by corrosion etc.
- If the pins protrude from the band.
- * Immediately consult the retailer from whom the watch was purchased or Grand Seiko international service network mentioned on CERTIFICATE OF GUARANTEE or our website.

Keep the watch and accessories out of the reach of babies and children.

Care should be taken to prevent a baby or a child accidentally swallowing the accessories. If a baby or child swallows the battery or accessories, immediately consult a doctor, as it will be harmful to the health of the baby or child.

⚠ CAUTION To indicate the risks of light injuries or material damages unless the following safety regulations are strictly observed.

Avoid wearing or storing the watch in the following places.

- Places where volatile agents (cosmetics such as polish remover, bug repellent, thinners, etc.) are vaporizing
- Places where the temperature drops below 5°C or rises above 35°C for a long time
- Places affected by strong magnetism or static electricity
- Places affected by strong vibrations
- Places of high humidity
- Dusty places

If you observe any allergic symptoms or skin irritation

Stop wearing the watch immediately and consult a specialist such as a dermatologist or an allergist.

Other cautions

- Replacement of the metallic band requires professional knowledge and skill.
Please ask the retailer from whom the watch was purchased for replacement of the metallic band, as there is a risk of hand or finger injury and fear of losing parts.
- Do not disassemble or tamper with the watch.
- Keep the watch out of the reach of babies and children. Extra care should be taken to avoid risks of any injury or allergic rash or itching that may be caused when they touch the watch.
- If your watch is of the fob or pendant type, the strap or chain attached to the watch may damage your clothes, or injure the hand, neck, or other parts of your body.
- Please keep in mind that if a watch is taken off and placed down as it is, the case back, the band and the clasp will rub against each other possibly causing scratches on the case back. We recommend placing a soft cloth between the case back, the band and the clasp after taking off your watch.

■ CHECK THE CALIBER NUMBER AND WATER-RESISTANT LEVEL

About the caliber number

The caliber number is a four-digit number that indicates the model of a movement (mechanical part of a watch). The Grand Seiko watch is mounted with an exclusive movement, and the mechanical caliber number starts with "9S", the spring drive caliber number starts with "9R" and the quartz caliber numbers are indicated with 4 digits starting with "9F", "8J" and "4J".

How to check the caliber number

The four-digit model number on the case back is the caliber number.

<Regular case back> <See-through case back> <Diver's watch case back>

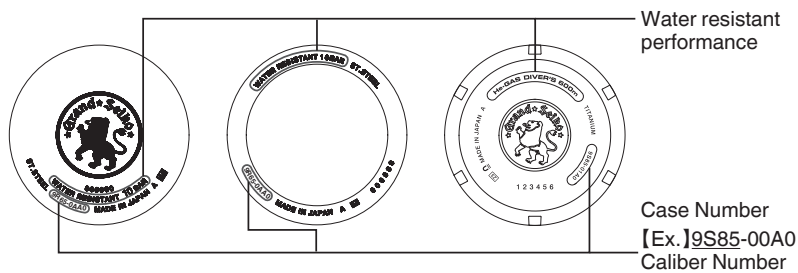

* The above illustrations are examples and may differ from the case back of the watch you purchased.

Water resistance

Refer to the table below for the description of each degree of water resistant performance of your watch before using.

Indication on the case back	Water resistant performance	Conditions of Use
No indication	Non-water resistance	Avoid drops of water or sweat
WATER RESISTANT	Water resistance for everyday life	The watch withstands accidental contact with water in everyday life ⚠ WARNING Not suitable for swimming
WATER RESISTANT 5 BAR	Water resistance for everyday life at 5 barometric pressures	The watch is suitable for swimming.
WATER RESISTANT 10 (20) BAR	Water resistance for everyday life at 10 (20) barometric pressures	The watch is suitable for diving not using an air cylinder.
DIVER'S WATCH 200m or AIR DIVER'S 200m	The watch can be worn for diving using a compressed air cylinder and can withstand water pressure to a depth of 200 meters.	The watch is suitable for genuine scuba diving use.
DIVER'S WATCH 600m FOR SATURATION DIVING or He GAS DIVER'S 600m	The watch can be worn for diving using helium gas and can withstand water pressure to a depth of 600 meters.	The watch is suitable for saturation diving.

* The orientation and design of the display may vary depending on the model.

■ CAUTIONS ON WATER RESISTANCE

⚠ CAUTION

Do not turn or pull out the crown when the watch is wet.



Water may get inside of the watch.

* If the inner surface of the glass is clouded with condensation or water droplets appear inside of the watch for a long time, the water resistant performance of the watch is deteriorated. Immediately consult the retailer from whom the watch was purchased or Grand Seiko international service network mentioned on CERTIFICATE OF GUARANTEE or our website.

Do not leave moisture, sweat and dirt on the watch for a long time.



Be aware of a risk that a water resistant watch may lessen its water resistant performance because of deterioration of the adhesive on the glass or gasket, or the development of rust on stainless steel.

Do not wear the watch while taking a bath or a sauna.



Steam, soap or some components of a hot spring may accelerate the deterioration of water resistant performance of the watch.

If water-resistant level of your watch is defined as "WATER RESISTANT"

⚠ WARNING

Do not use the watch in scuba diving or saturation diving.



The various tightened inspections under simulated harsh environment, which are usually required for watches designed for scuba diving or saturation diving, have not been conducted. For diving, use watches specifically designed for diving.

⚠ CAUTION

Do not pour running water directly from faucet.



The water pressure of tap water from a faucet is high enough to degrade the water resistant performance of a water resistant watch for everyday life.

If water-resistant level of your watch is defined as “DIVER'S WATCH 200m” or “AIR DIVER'S 200m”

- ⚠ WARNING**
- Never use the watch in saturation diving using helium gas.
 - While diving, never operate the watch in any other manner than described in this instruction manual.

- ⚠ CAUTION**
- Before using the diver's watch, you have to be properly trained in various types of diving and possess the requisite experience and skill to dive safely. When diving, strictly abide by the rules of diving.

If water-resistant level of your watch is defined as “DIVER'S WATCH 600m FOR SATURATION DIVING” or “He GAS DIVER'S 600m”

- ⚠ WARNING**
- This product is compatible with saturation diving. Do not use this product for saturation diving unless you have acquired the requisite experience and techniques for safe saturation diving, thoroughly familiarized yourself with the operation and handling of this product, and inspect all functions of this product prior to each dive.
 - Make sure you carefully check the depth rating indicated on the watch dial or on the case back, and never use the watch underwater deeper than the specified depth.
 - While diving, never operate the watch in any other manner than described in this instruction manual.

- ⚠ CAUTION**
- Before using the diver's watch, you have to be properly trained in various types of diving and possess the requisite experience and skill to dive safely. When diving, strictly abide by the rules of diving.

Precautions for diving (common during scuba diving and saturated diving)

○ Before diving

Inspect the following items before diving.
“NAMES OF THE PARTS”→ P. 15

- ① The time is correctly set.
- ② Turn the crown to wind up the watch so that it does not stop in the water.
“Screw down crown”→ P. 18
“How to wind the mainspring”→ P. 20
- ③ The rotating bezel turns smoothly.
(The bezel rotation must not be too loose or too tight.)
“Unidirectional rotating bezel”→ P. 33
- ④ The crown is completely screwed in.
“Screw down crown”→ P. 18
- ⑤ No abnormalities such as flaws or cracks exist on the band or glass.
- ⑥ The band is reliably fixed with spring bars, buckles or other parts.

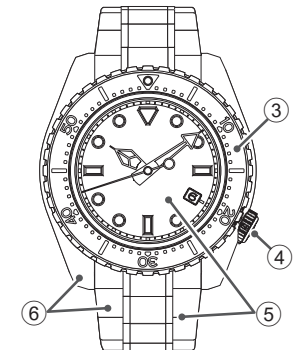
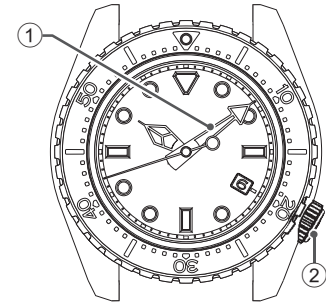

- ⚠ CAUTION**
- If you notice any abnormalities, contact the retailer from whom the watch was purchased or Grand Seiko international service network mentioned on CERTIFICATE OF GUARANTEE or our website.

○ While diving

Make sure to observe the following instructions when you wear the watch while diving.



Wear the watch within the water depth indicated on the dial.



Do not operate the crown or buttons underwater.



Take care not to bump the watch against hard objects such as rocks.



Bezel rotation may become slightly harder underwater, but this is not a malfunction.

○ After diving

Please follow the care instructions below after diving.



Rinse the watch in fresh water and wipe it thoroughly dry. Do not pour running water directly from a faucet onto the watch. Soak the watch in a container filled with water to wash it.



■ NAMES OF THE PARTS

9S85, 9S68, 9S65, 9S27 (Regular models)

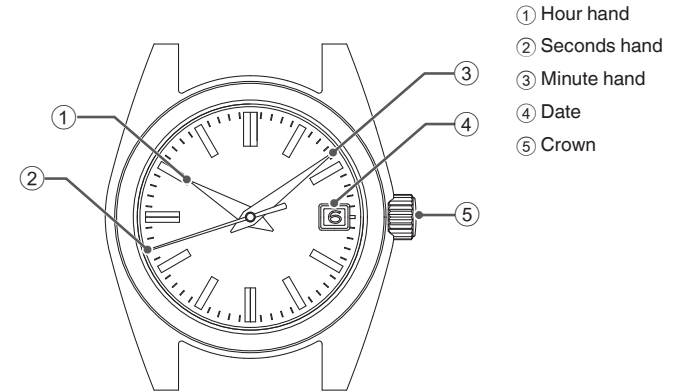

- ① Hour hand
- ② Seconds hand
- ③ Minute hand
- ④ Date
- ⑤ Crown

How to set the time and date → P. 20

9S85 (Diver's model)

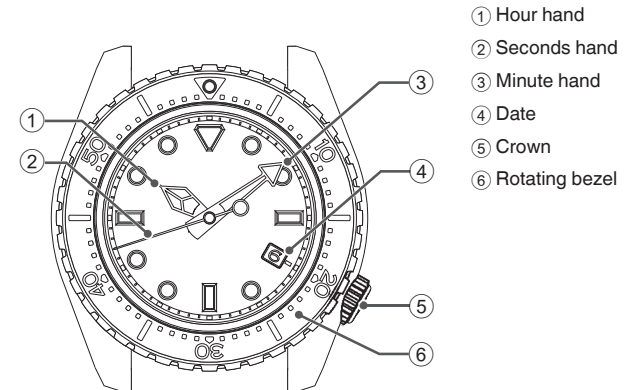

- ① Hour hand
- ② Seconds hand
- ③ Minute hand
- ④ Date
- ⑤ Crown
- ⑥ Rotating bezel

How to set the time and date → P. 20
 FUNCTIONS OF DIVER'S MODEL → P. 33
 Precautions for diving → P. 13

9S86, 9S66 (Regular models)

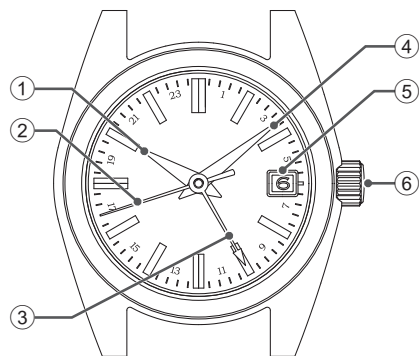

- ① Hour hand
- ② Seconds hand
- ③ 24-hour hand
- ④ Minute hand
- ⑤ Date
- ⑥ Crown

How to set the time and date → P. 22

9S86 (Model with a rotating bezel)

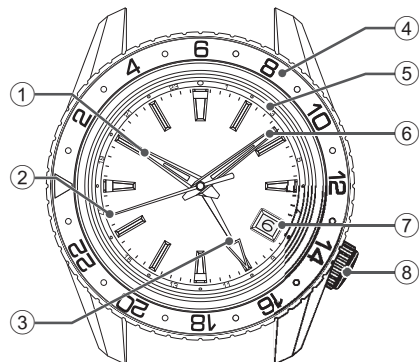

- ① Hour hand
- ② Seconds hand
- ③ 24-hour hand
- ④ Rotating bezel with a 24-hour indicators
- ⑤ Outer frame of the dial with a 24-hour indicators
- ⑥ Minute hand
- ⑦ Date
- ⑧ Crown

How to set the time and date → P. 22
Unidirectional rotating bezel → P. 33

9S64, 9S61

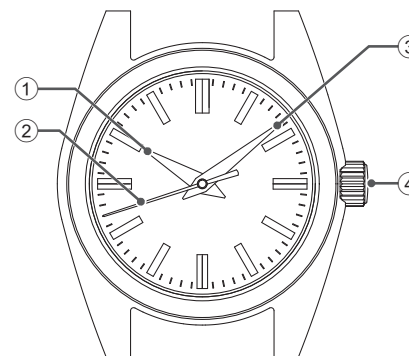

- ① Hour hand
- ② Seconds hand
- ③ Minute hand
- ④ Crown

How to set the time → P. 32

9S63

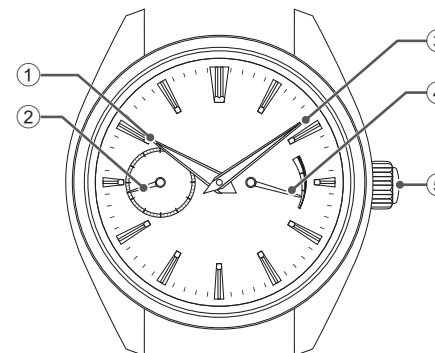

- ① Hour hand
- ② Seconds hand
- ③ Minute hand
- ④ Power reserve indicator
- ⑤ Crown

How to set the time → P. 31
Power reserve indicator → P. 19

* The orientation and design of the display may vary depending on the model.

HOW TO USE

Crown

There are two types of crowns, the regular one and one that can be locked. Please confirm the crown of the watch that you are using.

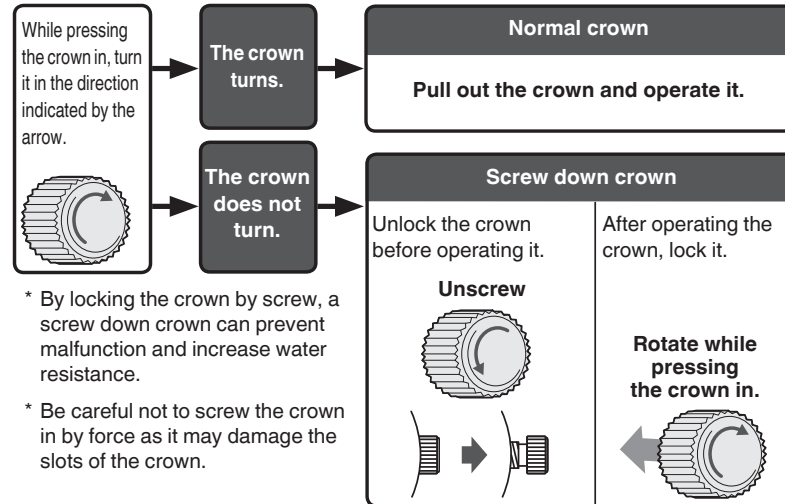

* By locking the crown by screw, a screw down crown can prevent malfunction and increase water resistance.

* Be careful not to screw the crown in by force as it may damage the slots of the crown.

* Turn the crown from time to time. → P. 41

Screw down crown

The screw down crown features a mechanism that can securely lock the crown when it is not being operated in order to prevent any operational errors and to improve its water resistant performance.

- It is necessary to unlock the screw down crown before operating it.
- Once you have finished operating the crown, make sure to relock it.

【To unlock the crown】

Turn the crown counterclockwise (6 o'clock direction) to unscrew it. Now the crown can be operated.

【To lock the crown】

Turn the crown clockwise (12 o'clock direction) while gently pressing it in toward the watch body until it stops.

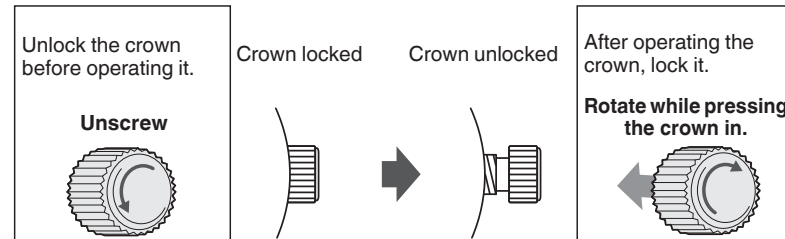

* When locking the crown, turn it slowly with care, ensuring that the screw is properly engaged. Be careful not to push it in forcefully, as doing so may damage the screw hole in the case.

Power reserve indicator

The power reserve indicator lets you know the winding state of the mainspring.

Before removing the watch from your wrist, observe the power reserve indicator to check if the watch has stored enough power to keep running until the next time you wear it. If necessary, wind the mainspring.

(To prevent the watch from stopping, wind the mainspring to store the excess power that will allow the watch to run for extra time.)

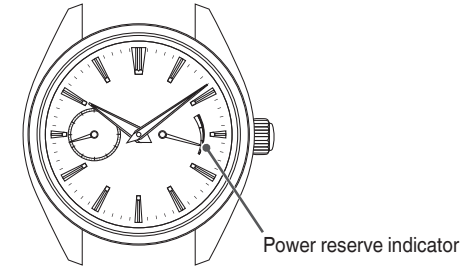

* The continuous operating time of the watch may vary depending on the condition of use, such as the number of hours you wear the watch or the extent of your movement while wearing it.

* In a case where you wear the watch for a short period of time, observe the power reserve indicator to check the level of the remaining power. If necessary, manually wind the mainspring.

How to read the power reserve indicator

Power reserve indicator			
Winding state of the mainspring	Fully wound	Half wound	Unwound
Number of hours the watch can run	Approximately 72 hours (3 days)	Approximately 36 hours (1.5 days)	The watch either stops or is running down.

* This watch is configured so that the spring cannot be over-wound.

Once the mainspring is fully wound, the mainspring slips inside, disengaging the winding mechanism. When this happens, you can still turn the crown without damaging the watch, however, please refrain from excessive operation of the mainspring.

HOW TO USE (FOR CAL. 9S85, 9S68, 9S65, 9S27)

How to wind the mainspring

- This watch is an automatic winding type (with manual winding function).
- The mainspring can be sufficiently wound automatically by natural movement of the arm while normally worn on the wrist. In addition, it can be wound by turning the crown.
- A stopped watch can be started by arm movement when it is worn on the wrist, however, before wearing the watch, wind the mainspring sufficiently and set the time and date. When winding the mainspring, turn the crown at the normal position clockwise (12 o'clock direction) slowly. If you turn the crown counterclockwise (6 o'clock direction), it will turn free.
The mainspring is sufficiently wound when the crown is turned approximately 45 times for Cal. 9S85, 60 times for Cal. 9S68 and 9S65, and 30 times for Cal. 9S27. When the mainspring is in the full-winding state, it is designed so that the mainspring slips if it is overwound. Therefore, it is not necessary to worry about breaking the mainspring, however, please refrain from excessive operation.

* It is recommended that you wear the watch on your wrist more than 10 hours a day to keep the mainspring wound up. If the mainspring is not wound up sufficiently, the watch may lose or gain time. If you do not wear the watch on your wrist, wind the mainspring up sufficiently by turning the crown by hand every day at a fixed time.

⚠ CAUTION

- Do not set the date between 10:00 p.m. and 1:00 a.m. (between 11:00 p.m. and 1:00 a.m. for Cal. 9S27).
If the date is set during this period of time, the date may not change when the next day comes, or this may cause damage.
- Due to its gear train mechanism, for setting the time of the mechanical watch correctly, the hands should be set back once slightly and then set forward to the correct time.

How to set the time and date

This watch is equipped with the date display function. The date changes once every 24 hours at around midnight. Therefore, if the a.m./p.m. is incorrectly set, the date will change around 12:00 p.m.

- ① Pull out the crown to the first click.
(If the watch is equipped with the screw down crown, unscrew the crown before pulling it out.)
- ② The date can be set by turning the crown clockwise (12 o'clock direction).
First turn the crown clockwise until the previous day's date from the desired date appears.

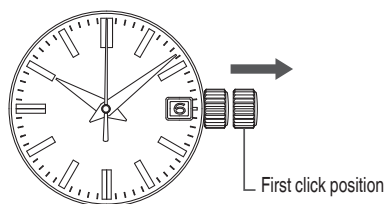

[Ex.] If you want to set the date to "6," set the date to "5" by turning the crown clockwise.

- ③ Pull out the crown to the second click when the seconds hand is at the 12 o'clock position. (The seconds hand stops.)
Turn the crown counterclockwise (6 o'clock direction) to rotate the hands clockwise until the desired date appears. When the date changes, the time is a.m. Further turn the crown to set the current time.
- ④ Push the crown back into the normal position in accordance with a time signal. The watch starts operating.

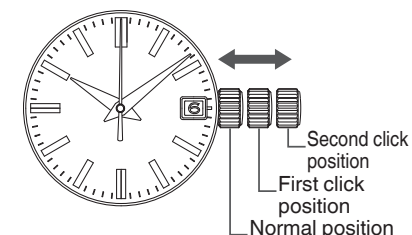

⚠ CAUTION

For models with a screw down crown, remember to screw the crown in.

Date adjustment at the end of the month

It is necessary to adjust the date after February (which has 28 days, 29 days in a leap year) and a 30 day month.

[Ex.] To adjust the date in the a.m. period on the first day of a month following a 30-day month

On the first day, "31" is displayed. Pull out the crown to the first click. Turn the crown clockwise (12 o'clock direction) to set the date to "1", and push the crown back in to the normal position.

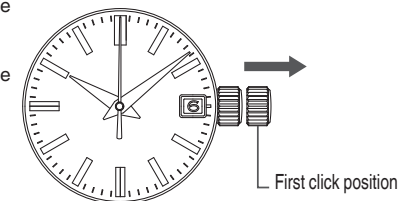

⚠ CAUTION

For models with a screw down crown, remember to screw the crown in.

HOW TO USE (FOR CAL. 9S86, 9S66)

How to wind the mainspring

- This watch is an automatic winding type (with manual winding function).
- The mainspring can be sufficiently wound automatically by natural movement of the arm while normally worn on the wrist. In addition, it can be wound by turning the crown.
- A stopped watch can be started by arm movement when it is worn on the wrist, however, before wearing the watch, wind the mainspring sufficiently and set the time and date. When winding the mainspring, turn the crown at the normal position clockwise (12 o'clock direction) slowly. If you turn the crown counterclockwise (6 o'clock direction), it will turn free.

The mainspring is sufficiently wound when the crown is turned approximately 45 times for Cal. 9S86 and 60 times for Cal. 9S66. When the mainspring is in the full-winding state, it is designed so that the mainspring slips if it is overwound. Therefore, it is not necessary to worry about breaking the mainspring, however, please refrain from excessive operation.

- * It is recommended that you wear the watch on your wrist more than 10 hours a day to keep the mainspring wound up. If the mainspring is not wound up sufficiently, the watch may lose or gain time. If you do not wear the watch on your wrist, wind the mainspring up sufficiently by turning the crown by hand every day at a fixed time.

How to set the time and date

- To set the time and date, set the 24-hour hand and minute hand first, and then set the hour hand and date.
- When setting the time, make sure that the mainspring is sufficiently wound.

How to set the time

- ① Make sure that the mainspring is sufficiently wound and the watch is working.
 - * When setting the date and time, ensure that the watch is working.

- ② Unlock the crown.
 - "Screw down crown" → P. 18

- ③ Pull out the crown to the second click when the seconds hand is pointing at the "0" second position. The seconds hand will stop on the spot.

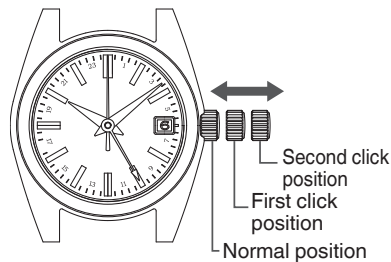

- ④ Turn the crown counterclockwise (6 o'clock direction) to rotate the 24-hour hand and minute hand clockwise and set them to the current time.

While doing so, set the minute hand a few minutes behind the correct time, and then slowly advance it to the desired time.

- * Only the 24-hour and minute hands are to be set first. Even if the hour hand is indicating incorrect time, or the date may be altered depending on the position of the hour hand, it is not necessary to make an adjustment at this stage.

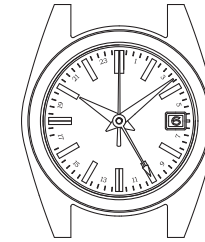

Set the 24-hour hand and minute hand.

- ⑤ Push the crown back in simultaneously with the time signal.

- * The setting of the 24-hour, minute and seconds hands is now completed.

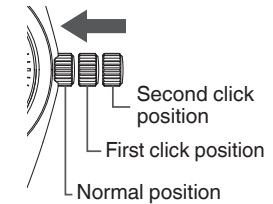

- ⑥ To move on to the hour hand and date setting, pull out the crown to the first click.

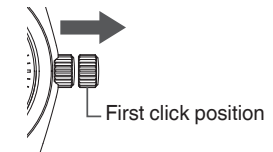

- ⑦ Turn the crown to set the hour hand. While turning the crown, the moment the date changes is midnight. When setting the hour hand, be sure that **AM/PM** is set correctly. Set the date also at this point if necessary.

- * The crown can be turned in either direction to set the date, however, it is recommended to turn the crown in the direction which enables you to set the date with a smaller adjustment.
- * Turn the crown slowly, checking that the hour hand moves in one-hour increments.
- * When setting the hour hand, the other hands may move slightly. However, this is not a malfunction.

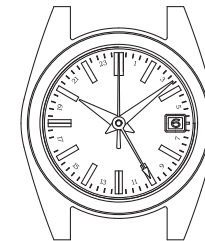

- ⑧ Push the crown back in to complete the time setting.
Relock the crown.
"Screw down crown"→ P. 18

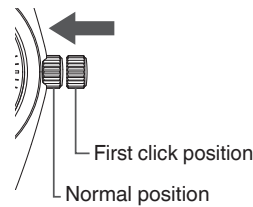

How to set the date

Two full rotations of the hour hand will change the date for one day. The date advances one day by turning the hour hand two full rotations clockwise (for 24 hours), while the date is set back one day by turning the hour hand two full rotations counterclockwise.

* Manual date adjustment is required on the first day after a month that has less than 31 days: February, April, June, September and November.

- ① Make sure that the mainspring is sufficiently wound and the watch is working.
* When setting the date and time, ensure that the watch is working.

- ② Unlock the crown.
"Screw down crown"→ P. 18

- ③ Pull out the crown to the first click.

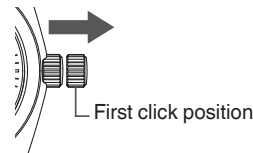

- ④ Each time the hour hand makes two full rotations by turning the crown, the date is adjusted one day. While turning the crown, the moment the date changes is midnight. When setting the hour hand, be sure that a.m./p.m. is set correctly.

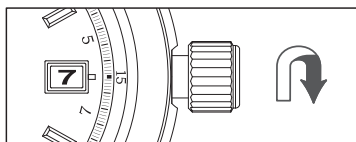

Turning the crown clockwise (12 o'clock direction):
Each time the hour hand makes two full rotations, the date is advanced one day.

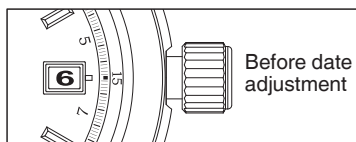

* The crown can be turned in either direction to set the date, however, it is recommended to turn the crown in the direction which enables you to set the date with a smaller adjustment.

* Turn the crown slowly.
* When setting the hour hand, the other hands may move slightly. However, this is not a malfunction.

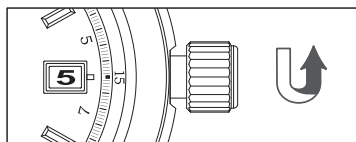

Turning the crown counterclockwise (6 o'clock direction):
Each time the hour hand makes two full rotations, the date is set back one day.

- ⑤ Upon completion of setting, make sure that the time indicated is correct, and then push the crown back in. The date setting is now completed.
Relock the crown.
"Screw down crown"→ P. 18

* The date is designed to work in conjunction with the movement of the hour hand, therefore, incorrect setting of a.m./p.m. will cause the date to change at noon.
* The crown can be turned in either direction to set the date, however, it is recommended to turn the crown in the direction which enables you to set the date with a smaller adjustment.
* Turn the crown slowly, checking that the hour hand moves in one-hour increments.
* When setting the hour hand, the other hands may move slightly. However, this is not a malfunction.

How to use the 24-hour hand

This watch has two different types of 24-hour hand usage.

<Type 1> : 24-hour hand as an a.m./p.m. indicator <Type 2> : 24-hour hand as a dual time indicator

Simply using the 24-hour hand to show the 24-hour time as an a.m./p.m. indicator. (This is the standard usage type for the 24-hour hand.)

Using the time difference adjustment function, set the 24-hour hand to indicate a time different from the time that the hour and minute hand indicate, which is of a place in a different time zone area with at least one hour of time difference from where you are.

Both the hour hand and the 24-hour hand are indicating the Japan time 10:00 a.m.
Hour hand : Japan time 10:00 a.m.
24-hour Hand : London time 1:00 a.m.

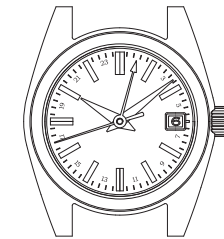
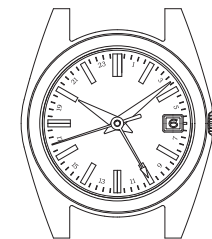

Time difference adjustment function

For example, while traveling abroad and staying in a place with a different time from where you live, you can conveniently set the watch to indicate the local time in the different time zone area without stopping the watch. The hour hand indicates the time of the place where you currently are, while the 24-hour hand indicates the time of the place of origin. The date works in conjunction with the movement of the hour hand. If the time difference is correctly adjusted, the watch displays the correct date of the place where you are staying.

How to use the time difference adjustment function

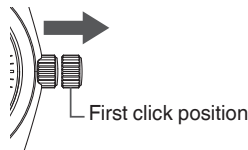
- ① Make sure that the mainspring is sufficiently wound and the watch is working.
 - * When setting the hour hand to use the time difference adjustment function, ensure that the watch is working.
- ② Unlock the crown.
 - "Screw down crown"→ P. 18
- ③ Pull out the crown to the first click.
 
- ④ Turn the crown to set the hour hand to indicate the time of the place where you are staying. Make sure that a.m./p.m. and date are correctly set.
 - * The date is designed to work in conjunction with the movement of the hour hand, therefore, incorrect setting of a.m./p.m. will cause the date to change at noon.
 - "List of time zone differences in major regions of the world"→ P. 29

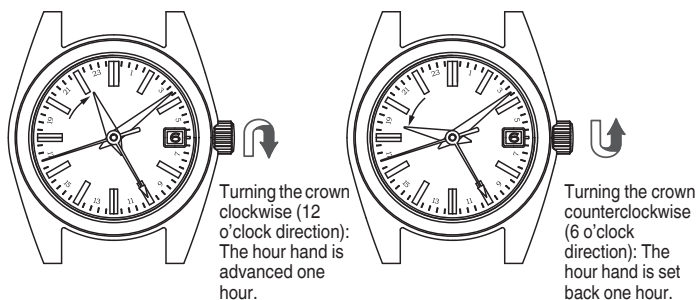

- * The crown can be turned in either direction to set the date, however, it is recommended to turn the crown in the direction which enables you to set the time difference with a smaller adjustment.
- * Turn the crown slowly, checking that the hour hand moves in one-hour increments.
- * While turning the crown, the moment the date changes is midnight.
- * When setting the hour hand, the other hands may move slightly. However, this is not a malfunction.

- ⑤ Upon completion of setting, make sure that the time indicated is correct, and then push the crown back in. The setting procedure is now completed.
 - Relock the crown.
 - "Screw down crown"→ P. 18

* If you set the time during any time between 9:00 p.m. and 1:00 a.m., temporarily set the hour hand back to 8:00 p.m., and then set the time.

Selectable display mode

With the time difference adjustment function, the watch features a dual time display which shows time in two different time zones. It offers two display modes which you can select to suit your needs and preference.

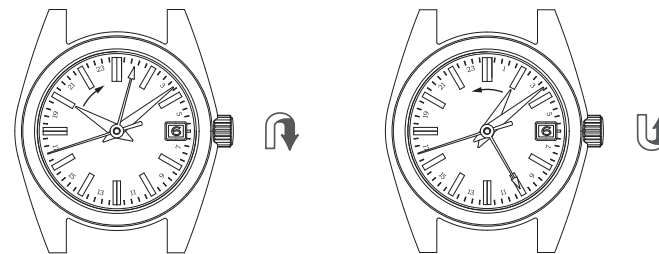

- | | | | |
|---------------|-------------------------------------|---------------|--------------------------------------|
| [Ex.1] | Hour hand and date : Area A (Japan) | [Ex.2] | Hour hand and date : Area B (London) |
| | 24-hour Hand : Area B (London) | | 24-hour Hand : Area A (Japan) |

Set the 24-hour hand first, and then set the hour hand.

How to use the bi-directional rotating bezel

Some models may have a bi-directional rotating bezel, the rim of the glass. By utilizing the 24-hour indicators imprinted on the rotating bezel, the watch can independently display the time in one or two different time zones in addition to the time indicated by the hour hand.

[Ex.] To set the 24-hour hand to indicate the time in Paris and Bangkok which are located in two different time zones, while setting the hour hand to display 10:08 a.m., Japan time.

* To use the 24-hour indicators on the rotating bezel to indicate the hour in Bangkok.

- ① First, set the ▽ mark on the rotating bezel to the 12 o'clock position.
- ② Refer to "Time difference adjustment function"→ P. 26, and set the hour and minute hands to 10:08 a.m. and align the 24-hour hand with "2" on the rotating bezel. Time in Paris is 8 hours behind Japan except for summer seasons when daylight saving time is observed.
- ③ There is a +6-hour time difference between Paris and Bangkok; the time in Bangkok is 6 hours ahead of the time in Paris (when daylight saving time is not in effect). Turn the rotating bezel counterclockwise to move the ▽ mark back 6 hours on the 24-hour indicators. The hour in Paris is shown by the 24-hour hand pointing to "2" (2:00 a.m.) of the 24-hour indicators on the dial (or the outer frame of the dial), while the hour in Bangkok is shown by the 24-hour hand pointing to "8" (8:00 a.m.) of the 24 hour indicators on the rotating bezel.

* "List of time zone differences in major regions of the world"→ P. 29

Turn the rotating bezel counterclockwise 6 gradations, so that the 24-hour indicators on the rotating bezel are advanced for 6 hours.

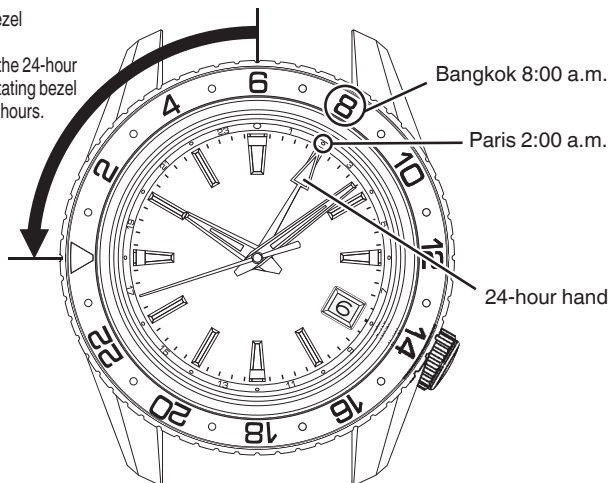

List of time zone differences in major regions of the world

Names of the cities	Time difference from Universal Time Coordinated (UTC)	Time difference from Japan Standard Time (JST)	Other cities in the same region
Tokyo	+9 hours	0 hours	Seoul
Beijing	+8 hours	-1 hour	Hong Kong, Singapore
Bangkok	+7 hours	-2 hours	Jakarta
Dacca	+6 hours	-3 hours	
Karachi	+5 hours	-4 hours	
Dubai	+4 hours	-5 hours	
Jeddah	+3 hours	-6 hours	Baghdad
Cairo	+2 hours	-7 hours	★Athens
★Paris	+1 hour	-8 hours	★Rome, ★Berlin
★London	0 hours	-9 hours	
★Azores	-1 hour	-10 hours	
★Rio de Janeiro	-3 hours	-12 hours	
Santo Domingo	-4 hours	-13 hours	
★New York	-5 hours	-14 hours	★Montreal
★Chicago	-6 hours	-15 hours	★Mexico City
★Denver	-7 hours	-16 hours	
★Los Angeles	-8 hours	-17 hours	★Vancouver
★Anchorage	-9 hours	-18 hours	
Honolulu	-10 hours	-19 hours	
Midway Island	-11 hours	-20 hours	
★Wellington	+12 hours	+3 hours	★Auckland
Nouméa	+11 hours	+2 hours	
★Sydney	+10 hours	+1 hour	Guam

* Regions marked with ★ use daylight saving time

* The time zone differences of each region and use of daylight saving time are based on data as of January 2019. These are subject to change according to the governments of the respective countries or regions.

HOW TO USE (FOR CAL. 9S64, 9S63)

How to wind the mainspring

- This watch is a manual winding type.
- In order to wind it up completely, please refer to the following table;

In case the watch is supposed to be wound up every day.	About 20 turns of the crown will wind up the watch fully.
In case the watch was not wound up more than three days.	About 60 turns of the crown will wind up the watch fully.

- For Cal. 9S63 models, look at the power reserve indicator to check the winding state (remaining power).
“Power reserve indicator”→ P. 19
- From the state of the mainspring being sufficiently wound, it continuously operates for approximately 72 hours or more.
- If the mainspring is not wound up sufficiently, the watch may lose or gain time. To attain a high accuracy, we suggest that the mainspring is wound up fully once a day at a fixed time.

Generally speaking, the crown of the manual winding mechanical watch cannot be turned further when it is wound up fully. However, the crown of the Cal. 9S64 and 9S63 can be turned endlessly even after the watch is fully wound up. If you keep turning the crown, that gives no effect to winding, but the watch is so designed as to make the winding a little tighter and not to damage the watch. However, please refrain from excessive operation.

* When the watch is used from a state in which the mainspring is unwound to a stop, it does not move immediately even if the mainspring is wound with the winding crown. This is because of the mechanical watch's feature that the mainspring torque (force) is weak at the beginning of mainspring winding. The seconds hand starts moving when the mainspring is wound to reach a certain degree of torque strength, while the watch can be made to move advance by shaking it to rotate the balance wheel forcibly.

Do not pull out the crown.
(If the watch is equipped with the screw down crown, unscrew the crown.)



Slowly turn the crown clockwise (12 o'clock direction) to wind the mainspring.

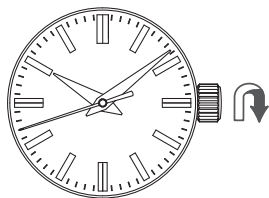
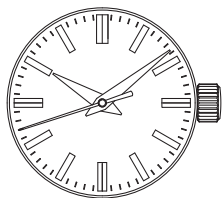

CAUTION For models with a screw down crown, remember to screw the crown in.

How to set the time

- ① Pull out the crown when the seconds hand is at the 12 o'clock position. (The seconds hand stops.)
Turn the crown to set the hour and minute hands to the desired time.

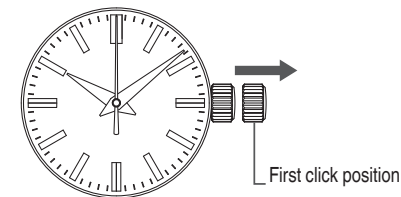

- ② Push the crown back in to the normal position in accordance with a time signal. The watch starts operating.
- * The orientation and design of the display may vary depending on the model.

Tips for more accurate time setting (For Cal. 9S63)

To ensure effective operation of the 9S63 mechanism, observe the following instructions when you set the time.

- ① Pull out the crown to the first click when the seconds hand is at the 12 o'clock position. (The seconds hand stops.)

- ② Turn the crown counterclockwise (6 o'clock direction) and stop when the minute hand is about one fourth of the way between the minute you want to set and the next minute.

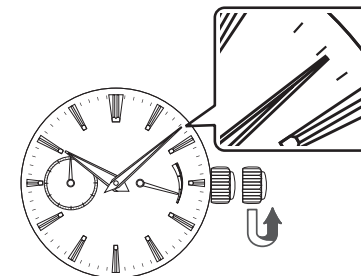

- ③ Turn the crown clockwise (12 o'clock direction) to return the minute hand to the desired time.

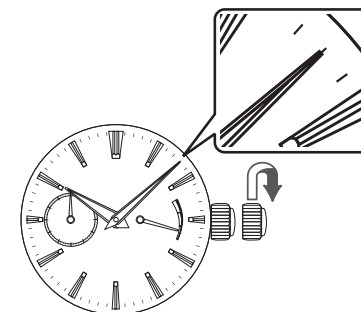

- ④ Gently push the crown back in to the normal position.

HOW TO USE (FOR CAL. 9S61)

How to wind the mainspring

- This watch is an automatic winding type (with manual winding function).
- The mainspring can be sufficiently wound automatically by natural movement of the arm while normally worn on the wrist. In addition, it can be wound by turning the crown.
- A stopped watch can be started by arm movement when it is worn on the wrist, however, before wearing the watch, wind the mainspring sufficiently and set the time. When winding the mainspring, turn the crown at the normal position clockwise (12 o'clock direction) slowly. If you turn the crown counterclockwise (6 o'clock direction), it will turn free. The mainspring is sufficiently wound when the crown is turned approximately 60 times. When the mainspring is in the full-winding state, it is designed so that the mainspring slips if it is overwound. Therefore, it is not necessary to worry about breaking the mainspring, however, please refrain from excessive operation.

* It is recommended that you wear the watch on your wrist more than 10 hours a day to keep the mainspring wound up. If the mainspring is not wound up sufficiently, the watch may lose or gain time. If you do not wear the watch on your wrist, wind the mainspring up sufficiently by turning the crown by hand every day at a fixed time.

⚠ CAUTION

- For models with a screw down crown, remember to screw the crown in.
- Due to its gear train mechanism, for setting the time of the mechanical watch correctly, the hands should be set back once slightly and then set forward to the correct time.

How to set the time

- ① Pull out the crown when the seconds hand is at the 12 o'clock position. (The seconds hand stops.) Turn the crown to set the hour and minute hands to the desired time.
- ② Push the crown back in to the normal position in accordance with a time signal. The watch starts operating.

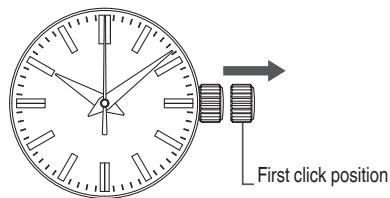

FUNCTIONS OF DIVER'S MODEL

Unidirectional rotating bezel

By using the rotating bezel, you can measure the elapsed time since the start of an event or an activity such as diving.

This watch has a unidirectional rotating bezel. As the evaluation of the remaining air in your cylinder is based on the information of the elapsed time of the dive, the rotating bezels for a diver's watch is designed to rotate only counterclockwise, so that the watch is prevented from displaying the elapsed time shorter than it actually is.

⚠ CAUTION

Make sure that you check the correct remaining amount of air in your cylinder before diving. Use the display of the elapsed time by the rotating bezel only as a guide during diving.

How to use the rotating bezel

- ① At the start of the activity, for which you want to measure the elapsed time (for example, when you start diving), rotate the bezel so that the ▼ mark on the bezel is aligned with the minute hand.
- ② Read the graduation on the rotating bezel to which the minute hand is pointing.

[Ex.] When you start diving at 10:10.

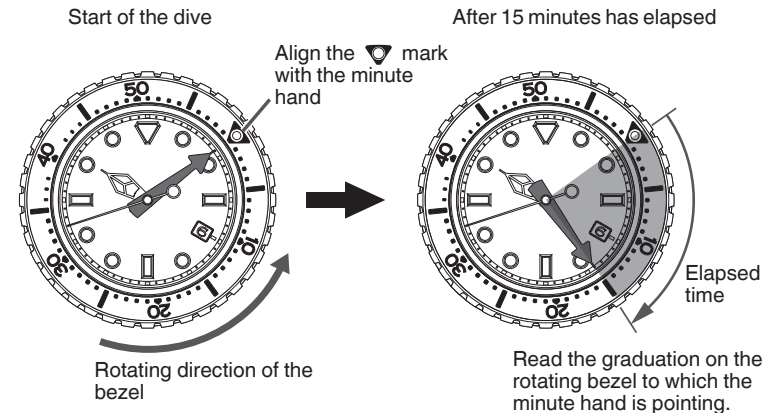

Slide adjuster

If your watch has a metallic band equipped with a slide adjuster mechanism, you can easily adjust the bracelet length by yourself. This is very useful when you wear the watch over a wetsuit or a heavy winter clothing.

How to use the slide adjuster

- ① Lift up the flap approximately 90° and press it down further approximately 20°, and hold it there.
* You may feel slight resistance, but doing this requires only a light force. Please do not push the flap down forcibly.
- ② Lightly pull the bracelet on the 6 o'clock side of the watch along the curved line of the bracelet.
* Again, doing this requires only a light force. Please do not pull the bracelet forcibly.
* The slider can be pulled out approximately 30 mm. Be careful not to pull it out beyond the limit mark inscribed on it.

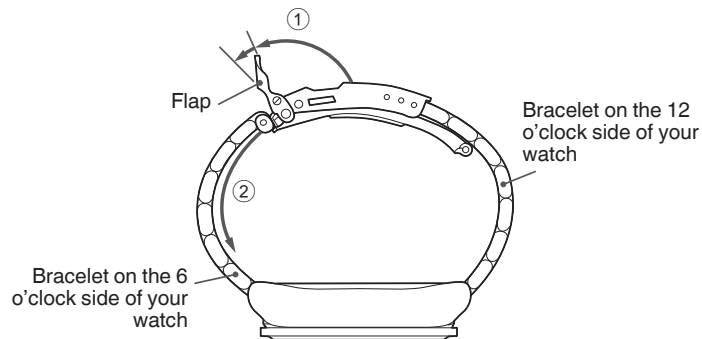

- ③ Holding down the push button, lift up the clasp to release the buckle, and strap the watch on your wrist.
- ④ Close the clasp first (4-1) and then the flap (4-2).
- ⑤ With the hand which is not wearing the watch, adjust the length of the slider so that the watch fits well around your wrist.

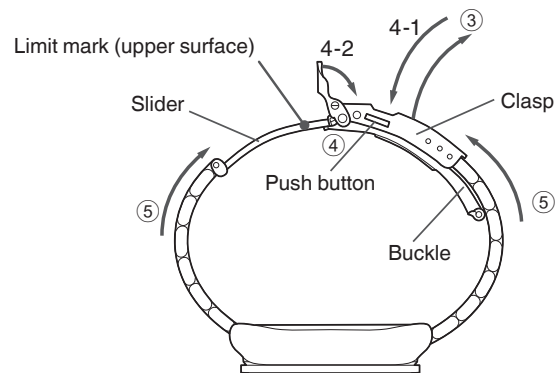

THE GRAND SEIKO STANDARD

Your Grand Seiko watch is built to the very highest standards to ensure that it keeps time as accurately as possible. In this section, we define the Grand Seiko Standard, what it means and how your watch is tested against it.

The "Grand Seiko Standard" is our own accuracy standard. Your watch has been tested individually and has met this standard. All Grand Seiko calibers are tested in the same way and for the same period but there are two standards, one for Grand Seiko men's watches and another for Caliber 9S27 which is used in Grand Seiko's women's watches. This is because the smaller size of Caliber 9S27 results in a different level of precision. "The Grand Seiko Standard defined" → P. 36

The movement in your Grand Seiko watch has been tested in our facilities for a period of 17 days, in six different positions and at three different temperatures. It has achieved or surpassed the standards of accuracy shown on page 36, with the accuracy being defined as a gain or loss per day (the "mean daily rate").

We specify "target values" for actual use and these are -1 second to +10 seconds per day for all calibers except 9S85 and 9S86 (-1 to + 8) and -5 to +10 for 9S27.

To judge the precision of your watch against these values, please measure the gain or loss over a week to ten days, and not just for one day, and in normal conditions.

If the mean daily rate is outside these levels, we will adjust the watch free of charge within three years of purchase. After that period, such adjustments will be chargeable. Equally, the adjustment will be chargeable if the watch has been subject to any of the conditions below.

- The watch has been used in ways that are not in line with the recommendations in this booklet, such as allowing it to be magnetized.
- It has been opened or tampered with by anyone other than a Grand Seiko repair center.
- It has been damaged as a result of a natural disaster such as a flood, fire or earthquake.
- Guaranteed conditions have been altered.

The Grand Seiko Special Standard

The Grand Seiko Special Standard is a precision standard even higher than the Grand Seiko Standard.

Watches that meet this standard are designated by the word "SPECIAL" printed on the dial.

The Grand Seiko Standard defined

Item	Unit	Standard	Cal. 9S27	Special Standard
Mean daily rate in six positions	Second/day	-3.0 ~ +5.0	-3.0 ~ +8.0	-2.0 ~ +4.0
Mean variation of daily rate	Second/day	Less than 1.8	Less than 3.2	Less than 1.6
Maximum daily rate between two consecutive daily rates in the same position	Second/day	Less than 4.0	Less than 6.0	Less than 3.0
Variation of rate between positions horizontal and vertical	Second/day	-6.0 ~ +8.0	-8.0 ~ +10.0	-5.0 ~ +7.0
Maximum daily rate between mean daily rate and any individual rate	Second/day	Less than 8.0	Less than 13.0	Less than 7.0
Variation of daily rate per 1 °C between 8 °C and 38 °C	Second/day/ °C	-0.5 ~ +0.5	-0.6 ~ +0.6	-0.3 ~ +0.3
Variation of daily rate per 1 °C between 23 °C and 38 °C	Second/day/ °C	-0.5 ~ +0.5	-0.6 ~ +0.6	-0.3 ~ +0.3
Rate-resumption	Second/day	-5.0 ~ +5.0	-6.0 ~ +6.0	4.0
Number of positions in inspection	6 positions			
Condition of temperature in inspection	8, 23, 38 °C			
Length of tests	17 days			

Description of Grand Seiko Standard Terminology

Item	Meaning
Position in inspection	Five orientations are specified by the International Standard ISO3159 so as to carry out various kinds of tests for time keeping. In addition thereto, in the GS inspection, 12 o'clock Up position in the state where a watch taken off the wrist is placed, is added, six orientations are specified. (Dial Up, Dial Down, 12 o'clock Up, 3 o'clock Up, 6 o'clock Up, and 9 o'clock Up)
Mean daily rate in six positions	Mean value of a total of 12 daily rates measured in six different positions, respectively, for two days. This is a target value indicating basic loss/gain per day of a watch, however, it is required to comprehensively judge the actual accuracy performance in consideration of other items.
Mean variation of daily rate	Mean value of a total of six variations of daily rates between the first day and second day when measured in six different positions for two days each. It indicates the degree which daily accuracy stabilizes in each position.
Maximum daily rate between two consecutive daily rates in the same position	Maximum value of a total of six variations of daily rates between the first day and second day when measured in six different positions for two days each. It indicates the degree which accuracy per day changes at maximum according to positions.
Variation of rate between positions horizontal and vertical	Indicates loss/gain in two positions at which a watch is most frequently used in daily life. It is a difference between mean daily rates for two days when a watch is placed in the Dial Up position and mean daily rates for two days when a watch is placed in the 6 o'clock Up position.
Maximum daily rate between mean daily rate and any individual rate	Maximum difference value between daily rates for 12 days in the test initial stage and mean daily rates. It indicates the degree at which the daily rate varies according to the manner for placing a watch.
Variation of daily rate per 1 °C between 8 °C and 38 °C	Variation in daily rates per 1 °C between 38 °C and 8 °C in the same position (Dial Up position). It indicates loss/gain in the temperature environment (taken-off state from the wrist) where a watch is used.
Variation of daily rate per 1 °C between 23 °C and 38 °C	Variation in daily rates per 1 °C between 38 °C and 23 °C in the same position (Dial Up position). It indicates loss/gain in the temperature environment (worn state of the wrist) where a watch is used.
Rate-resumption	Value obtained by subtracting mean daily rates of initial two days from daily rate of the last inspection day. It indicates the degree at which daily rate stabilizes after usage for a predetermined period.

The Grand Seiko Standard Inspection Certificate

- This certificate accompanies your watch. It shows the precision values achieved by the movement before the watch was cased and that the movement met the Grand Seiko Standard. The precision tests were conducted in an artificially controlled environment in our facility. The certificate shows the caliber number, the movement's individual number and the case's individual number.
- Normal usage accuracy of a mechanical watch varies depending on individual customer's use conditions such as winding state of the mainspring by movement amount of the customer's arm per day, temperature environment, and position (orientation of a watch). Accordingly, the actual normal usage accuracy when the watch is used by a customer may differ from the numerical value of each item specified in the Grand Seiko Standard.

CAUTION

Your Grand Seiko Inspection Certificate is unique and cannot be replaced or reissued if lost or after maintenance or adjustment.

Cautions for accuracy of mechanical watch

Mechanical watches have a mechanism that is moved by power generated when the mainspring is unwound, and small metal parts physically work together to control the accuracy. Fragile metal parts of a mechanical watch are easily influenced by external environment such as temperature, gravity, and shock. Also, conditions of use such as normal usage time and winding state of the mainspring can influence the loss/gain of the watch.

① Accuracy of mechanical watch is “mean daily rate.”

Accuracy of the quartz watch is indicated monthly or annually such as a monthly rate of ± 15 seconds or annual rate of ± 10 seconds. This indicates the degree of total difference in accuracy when the quartz watch is continuously used for a month or a year.

To the contrary, accuracy of the mechanical watch is normally indicated as a “mean daily rate.”

Accuracy of the mechanical watch slightly varies each day as it is influenced by various conditions of use, and it is normally unstable. Then it is required to judge whether the accuracy is satisfactory or not by checking the mean values in the case of use for a week to ten days, but not for only one day.

For normal usage accuracy of Grand Seiko mechanical watch, -1 to $+10$ seconds (-1 to $+8$ seconds for Cal. 9S86 and 9S85, -5 to $+10$ seconds for Cal. 9S27) per day are specified as target values. If the mean value exceeds the abovementioned target value in the normal usage condition when the watch is used for a week to ten days, we will adjust it.

* Adjustment is provided free of charge for three years after purchase, then charged thereafter. However, please note that the parts that are age-deteriorated due to long duration of use may not be adjusted to your desired accuracy. For details, refer to pages P. 35 and P. 39.

② Factor influencing accuracy -1: Wound amount of the mainspring

In order to use the mechanical watch at better accuracies, it is required to supply a constant strong energy wherever possible to respective parts.

In the state where the mainspring is fully wound, accuracy is stable, however, when the mainspring is unwound to weaken energy to be supplied, the parts controlling accuracy tends to be externally influenced, and accuracy becomes unstable.

In order to use a mechanical watch at a steady accuracy, it is recommended to use it in a condition where the mainspring is sufficiently wound.

③ Factor influencing accuracy -2: Temperature influence

Mechanical watch parts are metal which slightly elongate and contract by change in temperature, and this influences accuracy. Normally, under high temperatures, it tends to lose time, and under low temperatures, it tends to gain time.

④ Factor influencing accuracy -3: Difference by position (orientation of a watch)

Parts related to accuracy of a mechanical watch are also influenced by the earth's gravity. For example, gain or loss differs when a watch is horizontally placed and when it is vertically placed in the 12 o'clock up position.

When the watch is not worn on the wrist, accuracy errors that occur while wearing can also be compensated to some extent according to the position. Try to place it in various positions to find the position appropriate to your watch.

TO PRESERVE THE QUALITY OF YOUR WATCH

After-sale service

Notes on guarantee and repair

- Contact the retailer from whom the watch was purchased or Grand Seiko international service network mentioned on CERTIFICATE OF GUARANTEE or our website for repair or overhaul.
- Within the guarantee period, present the certificate of guarantee to receive repair services.
- Guarantee coverage is provided in the certificate of guarantee. Read carefully and retain it.
- For repair services after the guarantee period has expired, if the functions of the watch can be restored by repair work, we will undertake repair services upon request and payment.

Replacement parts

- Please keep in mind that if original parts are not available, they may be replaced with substitutes whose outward appearance may differ from the originals.

Inspection and adjustment by disassembly and cleaning (overhaul)

- Periodic inspection and adjustment by disassembly and cleaning (overhaul) is recommended approximately once every 3 to 4 years in order to maintain optimal performance of the watch for a long time.
- The movement of this watch has a structure that consistent pressure is applied on its power-transmitting wheels. To ensure these parts work together properly, periodic inspection including cleaning of parts and movement, oiling, adjustment of accuracy, functional check and replacement of worn parts is needed. Inspection and adjustment by disassembly and cleaning (overhaul) within 3 to 4 years from the date of purchase is highly recommended for longtime use of your watch. According to use conditions, the oil retaining condition of your watch mechanical parts may deteriorate, abrasion of the parts may occur due to contamination of oil, which may ultimately lead the watch to stop. As the parts such as the gasket may deteriorate, water-resistant performance may be impaired due to intrusion of perspiration and moisture. Please contact the retailer from whom the watch was purchased for inspection and adjustment by disassembly and cleaning (overhaul). For replacement of parts, please specify “GRAND SEIKO GENUINE PARTS”. When asking for inspection and adjustment by disassembly and cleaning (overhaul), make sure that the gasket and push pin are also replaced with new ones.
- When your watch is inspected and adjusted by disassembly and cleaning (overhauled), the movement of your watch may be replaced.

Guarantee

Within the guarantee period, we guarantee free repair/adjustment service against any defects according to the following guarantee regulations, provided that the watch was properly used as directed in this instruction booklet.

Guarantee coverage

- The watch body (movement, case) and metallic band.

Exceptions from guarantee

In following cases, repair/adjustment services will be provided at cost even within the guarantee period or under guarantee coverage.

- Exchange of leather, silicone, or fabric band.
- Troubles or damage to the case, glass, or band, caused by use.
- Scratches or grime caused by accidents or improper usage.
- Troubles and damage caused by acts of God, natural disasters including fire, floods or earthquakes.
- Text in certificate has been altered.
- No certificate is presented.

Procedure to claim free repair services

- For any defects under guarantee, submit the watch together with the attached certificate of guarantee to the retailer from whom the watch was purchased.
- In the case where you cannot accept the guarantee from the retailer from whom the watch was purchased due to gift-giving or relocation, etc., ask Grand Seiko international service network mentioned on CERTIFICATE OF GUARANTEE or our website by attaching the certificate without fail.

Others

- For the watch case, dial plate, hands, glass, band etc., some alternative parts may be used for repair if necessary.
- For length adjustment service of metallic band, ask the retailer from whom the watch was purchased or Grand Seiko international service network mentioned on CERTIFICATE OF GUARANTEE or our website.
Other retailers may undertake the service on a chargeable basis or may not undertake the service.
- Free repair services are guaranteed only under the period and conditions specified in the certificate of guarantee.
It does not affect specific legal rights of a consumer.

Daily care

The watch requires good daily care

- Do not wash the watch when its crown is at the extended position.
- Wipe away moisture, sweat or dirt with a soft cloth.
- After soaking the watch in seawater, be sure to wash the watch in clean pure water and wipe it dry carefully. Do not pour running water directly from a faucet onto the watch. Put some water into a bowl first, and then soak the watch in the water to wash it.

* If your watch is rated as “non-water resistant” or “water resistant for daily use”, do not wash the watch.

“CHECK THE CALIBER NUMBER AND WATER-RESISTANT LEVEL”→ P. 10

Turn the crown from time to time

- In order to prevent corrosion of the crown, turn the crown from time to time.
- The same practice should be applied to a screw down crown.
“Crown”→ P. 18

Band

The band touches the skin directly and becomes dirty from sweat or dust. Therefore, lack of care may accelerate deterioration of the band or cause skin irritation or stain on the sleeve edge. The watch requires a lot of attention for long usage.

Metallic band

- Moisture, sweat or soil will cause rust even on a stainless steel band if they are left for a long time.
- Lack of care may cause a yellowish or gold stain on the lower sleeve edge of shirts.
- Wipe off moisture, sweat or soil with a soft cloth as soon as possible.
- To clean the soil around the joint gaps of the band, wipe it out in water and then brush it off with a soft toothbrush (Protect the watch body from water splashes by wrapping it up in plastic wrap etc.)
Wipe off the remaining moisture with a soft cloth.
- Because some titanium bracelets use pins made of stainless steel, which has outstanding strength, rust may form in the stainless steel parts.
- If rust advances, pins may poke out or drop out, and the watch case may fall off the bracelet, or the clasp may not open.
- If a pin is poking out, personal injury may result. In such a case, refrain from using the watch and request repair.

Leather band

- A leather band is susceptible to discoloration and deterioration from moisture, sweat and direct sunlight.
- Wipe off moisture and sweat as soon as possible by gently blotting them up with a dry cloth.
- Do not expose the watch to direct sunlight for a long time.
- Please take care when wearing a watch with light-colored band, as dirt is likely to show up.
- Refrain from wearing a leather band watch other than Aqua Free bands while swimming, and when working with water even if the watch itself is water-resistant enforced for daily use.

Silicone band

- As for material characteristics, the band is easily dirtied, and may be stained and discolored. Wipe off dirt with a wet cloth or cleaning tissue.
- Unlike bands of other materials, cracks may result in the band being cut. Take care not to damage the band with an edged tool.

Notes on skin irritation and allergy

Skin irritation caused by a band has various reasons such as allergy to metals or leathers, or skin reactions against friction on dust or the band itself.

Notes on the length of the band

Adjust the band to allow a little clearance with your wrist to ensure proper airflow. When wearing the watch, leave enough room to insert a finger between the band and your wrist.



Magnetic resistance (Magnetic influence)

Affected by nearby magnetism, a watch may temporarily gain or lose time or stop operating.

Indication on the case back	Conditions of use	Certified level
No indication * For diver's model	Keep the watch more than 5 cm away from magnetic products.	4,800 A/m
	Keep the watch more than 1 cm away from magnetic products.	16,000 A/m
MAGNETIC RESISTANT 40000A/m	The watch can maintain its performance in most cases where it is brought close to (at least 1 cm spaced from) magnetic products not only in normal daily life circumstances but also in a special work environment.	40,000 A/m

* A/m (ampere meter) is the international unit (SI unit) for indicating the magnetic field.

If the watch becomes magnetized and its accuracy deteriorates to an extent exceeding the specified rate under normal use, the watch may need to be demagnetized. In this case, you will be charged for demagnetization and accuracy readjustment even if it happens within the guarantee period.

Examples of common magnetic products that may affect watches

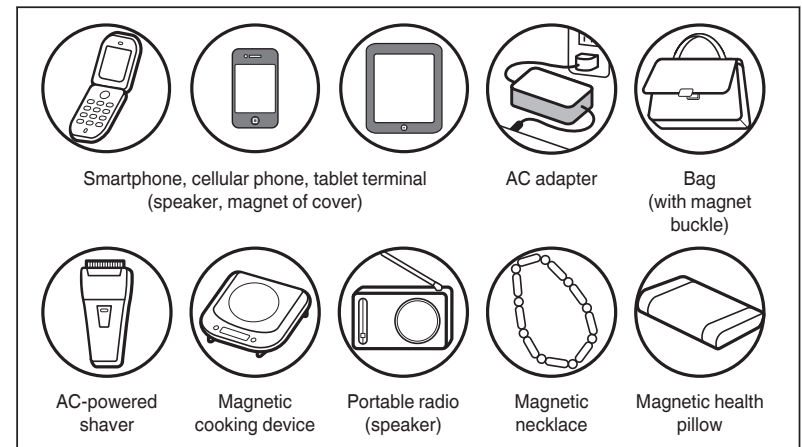

The reason why this watch is affected by magnetism

The built-in balance spring is provided with a magnet, which may be influenced by a strong external magnetic field.

Lumibrite

If your watch has Lumibrite

Lumibrite is a newly-developed luminous paint that absorbs light energy of the sunlight and lighting apparatus in a short time and stores it to emit light in the dark. For example, if exposed to a light of more than 500 lux for approximately 10 minutes, Lumibrite can emit light for 3 to 5 hours. Please note, however, Lumibrite emits the light it stores, the luminance level of the light decreases gradually over time. The duration of the emitted light may also differ slightly depending on such factors as the brightness of the place where the watch is exposed to light and the distance from the light source to the watch.

* In general, when you enter a dark place from a bright environment, your eye cannot adapt to the change in light levels quickly. At first, you can hardly see anything, but as time passes, your vision gradually improves. (Dark adaptation of the human eye)

* Lumibrite is a luminous paint that is completely harmless to human beings and the natural environment; containing no noxious materials such as radioactive substance.

Reference data on the luminance

Condition		Illumination
Sunlight	Fine weather	100,000 lux
	Cloudy weather	10,000 lux
Indoor (Window-side during daytime)	Fine weather	more than 3,000 lux
	Cloudy weather	1,000 to 3,000 lux
	Rainy weather	less than 1,000 lux
Lighting apparatus (40-watt daylight fluorescent light)	Distance to the watch: 1 m	1,000 lux
	Distance to the watch: 3 m	500 lux (average room luminance)
	Distance to the watch: 4 m	250 lux

Troubleshooting

Troubles	Possible Causes	Solutions
The watch stops operating.	The mainspring has not been wound.	Wind the mainspring or swing the watch for a few times so that the watch will start operating. If this action does not correct the condition, consult the retailer from whom the watch was purchased.
The watch temporarily loses/gains time.	The watch has been left in extremely high or low temperatures for a long time.	Normal accuracy will resume when the watch returns to normal temperature.
	The watch was brought into close contact with a magnetic object.	Accuracy cannot be recovered. Restoring the original accuracy requires demagnetization (repair). Consult the retailer from whom the watch was purchased.
	The watch was dropped, worn while playing active sports, hit against hard surfaces, or exposed to strong vibrations.	Accuracy cannot be recovered. Consult the retailer from whom the watch was purchased.
The date changes during daytime.	Inspection, adjustment, and overhaul cleaning have not been performed for the watch for more than 3 years.	Consult the retailer from whom the watch was purchased.
	A.m./p.m. is not correctly set.	Advance the hour hand for 12 hours and reset the time and date.
Blur in the display persists.	Small amount of water has got inside the watch due to deterioration of the gasket, etc.	Consult the retailer from whom the watch was purchased.

* For the solution of troubles other than above, contact the retailer from whom the watch was purchased.

■ SPECIFICATIONS (Movement)

Caliber no.	9S86, 9S85
Common features	Hour Hand, Minute Hand, Seconds Hand, Date.
Extra features for Cal. 9S86 only	24-hour hand, Time difference adjustment function interrelated with the day display
Vibrations	36,000/hour (10/second)
Loss/gain (Grand Seiko Standard)	Mean daily rate*: -3 to +5 seconds
Loss/gain (Grand Seiko Special Standard)	Mean daily rate*: -2 to +4 seconds
Driving system	Automatic winding type with manual winding function
Power reserve	For 55 hours or more.* From the state of the mainspring being sufficiently wound.
Jewels	37 jewels

Caliber no.	9S66, 9S68, 9S65, 9S61, 9S64, 9S63
Common features	Hour Hand, Minute Hand, Seconds Hand.
Extra features for Cal. 9S66, 68, 65	Date
Extra features for Cal. 9S66 only	24-hour Hand
Extra features for Cal. 9S63 only	Power reserve indicator
Vibrations	28,800/hour (8/second)
Loss/gain	Mean daily rate*: -3 to +5 seconds
Driving system	9S66, 9S68, 9S65, 9S61: Automatic winding type with manual winding function 9S64, 9S63: Manual winding type
Power reserve	For 72 hours or more.* From the state of the mainspring being sufficiently wound.
Jewels	9S66, 9S68, 9S65: 35 jewels, 9S63, 9S61: 33 jewels, 9S64: 24 jewels

Caliber no.	9S27
Features	Hour Hand, Minute Hand, Seconds Hand, Date.
Vibrations	28,800/hour (8/second)
Loss/gain	Mean daily rate*: -3 to +8 seconds
Driving system	Automatic winding type with manual winding function
Power reserve	For 50 hours or more.* From the state of the mainspring being sufficiently wound.
Jewels	35 jewels

Mean daily rate* : A mean value of daily rates in a condition where the movement before assembly in a case are measured in 6 positions in a fixed manner under artificially controlled environment for 17 days.

Caution: Depending on conditions of use (such as normal usage time, temperature environment, and winding state), accuracy may exceed the abovementioned range. Therefore, for normal usage accuracy when it is actually used, -1 to +10 seconds (-1 to +8 seconds for Cal. 9S86 and 9S85, -5 to +10 seconds for Cal. 9S27) per day are specified as target values.

* The specifications are subject to change without prior notice due to product improvement.